



SOLENOID OPERATED DIRECTIONAL VALVE DEUTSCH CONNECTION TYPE



SPECIFICATIONS







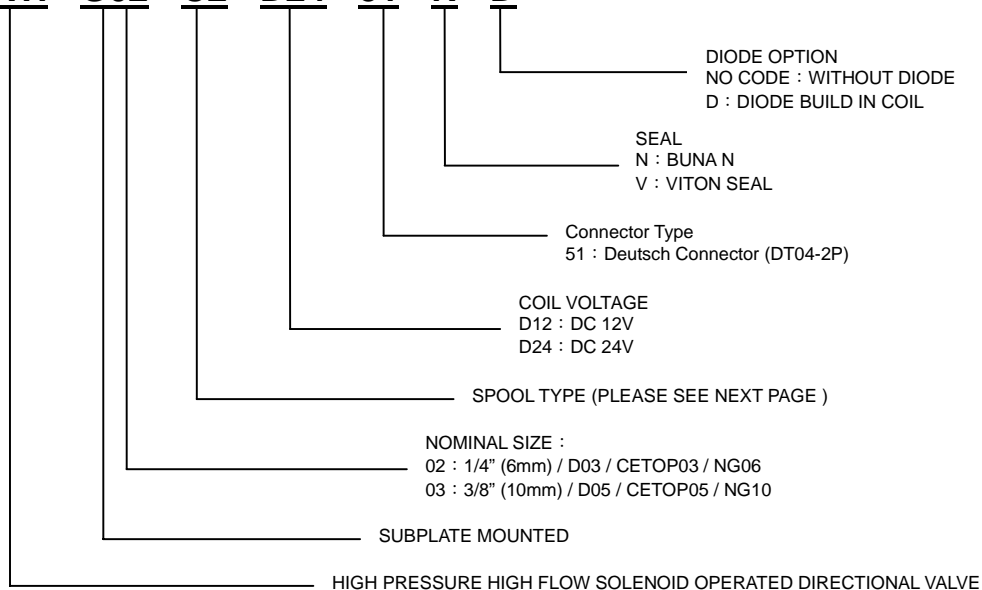



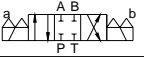

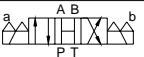

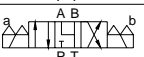
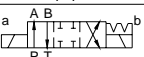
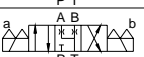
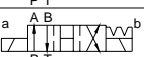
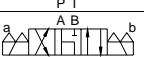
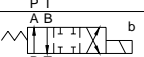

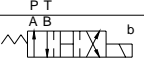
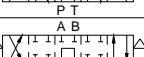
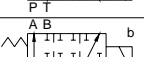
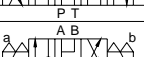

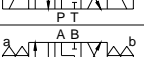



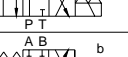

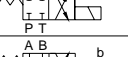

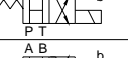
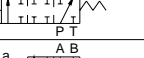
Mounting Pattern	ISO 03 /NFPA D03/CETOP03/NG 06
Maximum Operating Pressure	310 BAR (4500 PSI)
Maximum Tank Line Back Pressure	160 BAR (2500 PSI)
Current	2.6A (DC 12V)
	1.3A (DC 24V)
Power Consumption	28.8 Watts
Insulation	Class H
Surge Protection	(Option) Built-in Diode, Surge Voltage < 1 Voltage
Fluid Viscosity	10~1000 CST
Permissible Contamination Level	With NAS 1638 Class 12 (ISO 21/18)
Operation Fluid and Temperature	Mineral Oil, Anti-Water -25°C ~+90°C (-13°F ~+194°F)
Vibration Tolerance	JIS D1601 Type-3 Class-D Stage-7 @ 0.4mm (0.016 inch) displacement @ 6.8G @ 66.7 HZ *3 Directions
Waterproof Tolerance	JIS D0203 S2 & JIS D0203 D2 (equivalent to IP67)
	Proven by heat up to saturated temperature and diving into 4" depth 86°F water repeat 10 cycles
Maximum Frequency of Operation	250 cycles/minute
Response Time	≤ 50 msec On
	≤ 100 msec Off
Corrosion Resistance Treatment	Zinc Phosphate Compound
Weight	Single Solenoid approx. 1.5 kgs (3.3 lbs)
	Double Solenoid approx. 2.0 kgs (4.4 lbs)

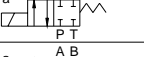
HOW TO ORDER

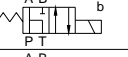
SWH - G02 - C2 - D24 - 51 - N - D

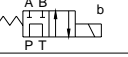
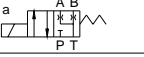
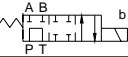

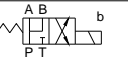
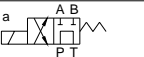
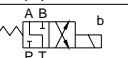
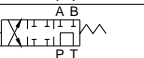
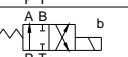
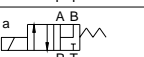
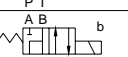
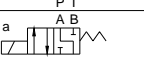
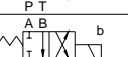
SPOOL TYPE

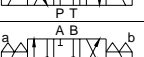
APPLICATION	TYPE	GRAPHIC SYMBOL	APPLICATION	TYPE	GRAPHIC SYMBOL
3 POSITIONS SPRING CENTERED	C2		2 POSITIONS NO SPRING	N2	
	C3			N3	
	C4		2 POSITIONS DETENT	D2	
	C40			D3	
	C5		2 POSITIONS SPRING OFFSET (SOL b)	B2	
	C6			B3	
	C60			B20	
	C7			B21	
	C8		2 POSITIONS SPRING OFFSET (SOL a)	B2S	
C9		B3S			
2 POSITIONS SPRING OFFSET (SOL b)	C2B			B4S	
	C3B			B20S	
	C4B			C2BS	
	C40B			C3BS	
	C5B			C4BS	
	C6B			C40BS	
	C60B			C5BS	
	C7B			C6BS	
	C8B		C60BS		
	C9B		C7BS		
C5SB		C8BS			
C8SB		C9BS			
C9SB		3 POSITIONS SPRING CENTERED	C5S		
			C8S		
			C9S		

PORT INTERCONNECTION

- WITH "SOL.a" ENERGIZED P → A B → T.
- WITH "SOL.b" ENERGIZED P → B A → T.
- BUT PORT INTERCONNECTIONS ARE REVERSED FOR C5,C6,C60 TYPE .



SOLENOID OPERATED DIRECTIONAL VALVE DEUTSCH CONNECTION TYPE

INSTALLATION DIMENSIONS

● SWH-G02-C* - D* - 51 - * - *

Mounting Surface: ISO 4401-AB-03-4-A

UNIT: mm(inch)

WEIGHT: 2.0kgs(4.4lbs)

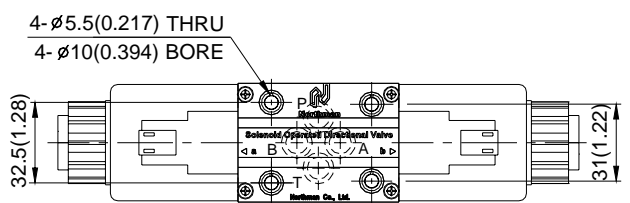

CONNECTOR DETAILS
EQUIVALENT TO DEUTSCH COMPANY
RECEPTACLE: DT04-2P
RECEPTACLE WEDGE: W2P
PIN CONTACT:0460-202-16141

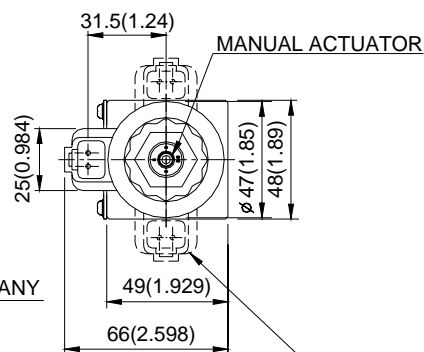

THREE POSITIONS OF CABLE
CONNECTIONS ARE AVAILABLE
BY LOOSENING "LOCK NUT"
AS SHOWN

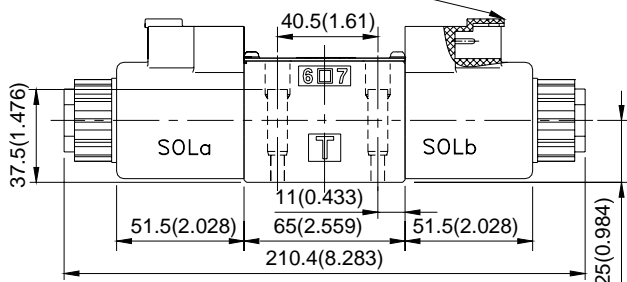

● SWH-G02-C* B/B* - D* - 51 - * - *

Mounting Surface: ISO 4401-AB-03-4-A

UNIT: mm(inch)

WEIGHT: 1.5kgs(3.3lbs)

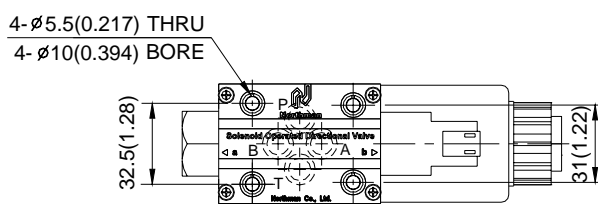

CONNECTOR DETAILS
EQUIVALENT TO DEUTSCH COMPANY
RECEPTACLE: DT04-2P
RECEPTACLE WEDGE: W2P
PIN CONTACT:0460-202-16141

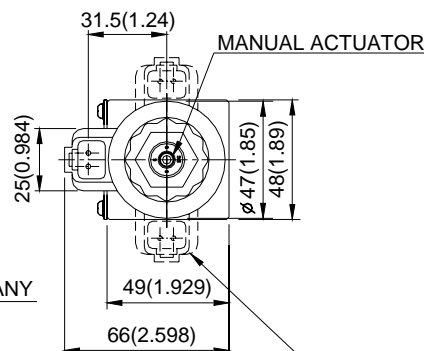

THREE POSITIONS OF CABLE
CONNECTIONS ARE AVAILABLE
BY LOOSENING "LOCK NUT"
AS SHOWN

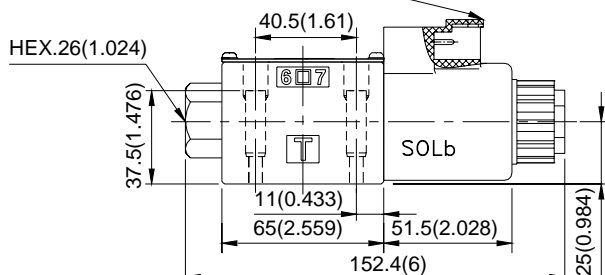



SOLENOID OPERATED DIRECTIONAL VALVE DEUTSCH CONNECTION TYPE

Mounting Surface: ISO 4401-AB-03-4-A

● SWH-G02-C* BS/B* S-D*-51-* - *

UNIT: mm(inch)

WEIGHT: 1.5kgs(3.3lbs)

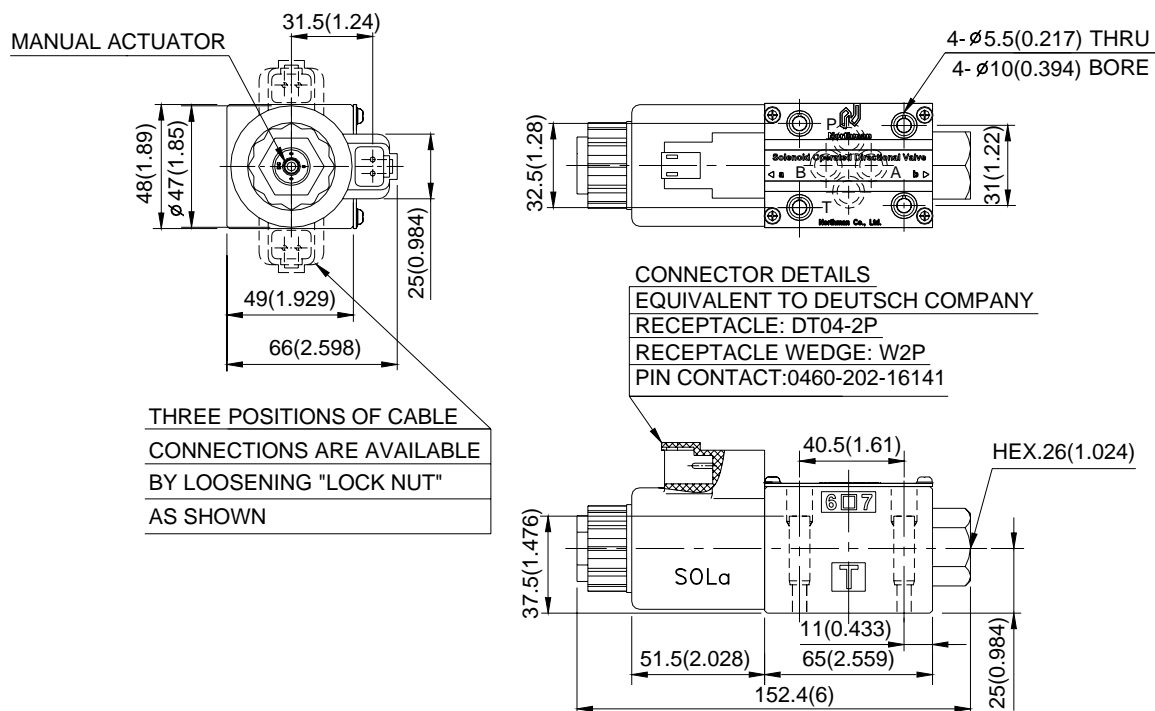

* DETAILS OF PLUG
EQUIVALENT TO DEUTSCH COMPANY
PLUG: DT06-2S
PLUG WEDGE: W2S
SOCKET CONTACT:0462-201-16141



SOLENOID OPERATED DIRECTIONAL VALVE DEUTSCH CONNECTION TYPE

INSTALLATION DIMENSIONS

● SWH-G03-C* - D* - 51 - * - *

Mounting Surface: ISO 4401-AC-05-4-A

UNIT: mm(inch)

WEIGHT: 5.5kgs(12.1lbs)

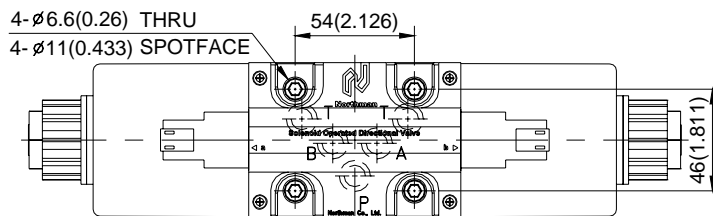

CONNECTOR DETAILS
EQUIVALENT TO DEUTSCH COMPANY
RECEPTACLE: DT04-2P
RECEPTACLE WEDGE: W2P
PIN CONTACT:0460-202-16141

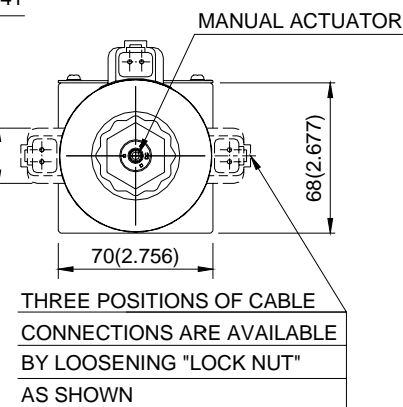
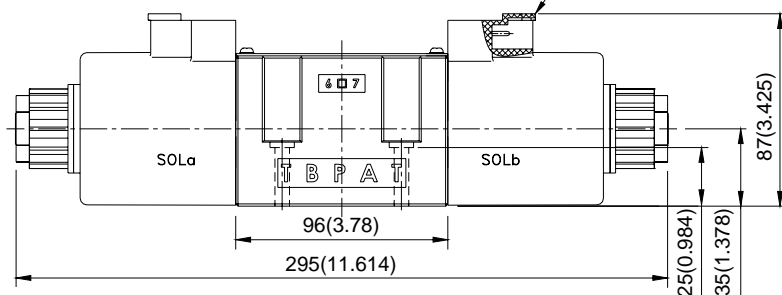

● SWH-G03-C* B/B* - D* - 51 - * - *

Mounting Surface: ISO 4401-AC-05-4-A

UNIT: mm(inch)

WEIGHT: 4kgs(9.68lbs)

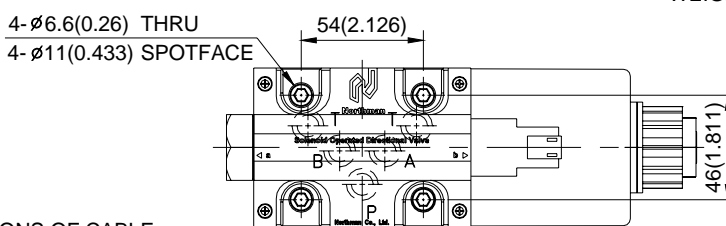

THREE POSITIONS OF CABLE CONNECTIONS ARE AVAILABLE BY LOOSENING "LOCK NUT" AS SHOWN

CONNECTOR DETAILS
EQUIVALENT TO DEUTSCH COMPANY
RECEPTACLE: DT04-2P
RECEPTACLE WEDGE: W2P
PIN CONTACT:0460-202-16141

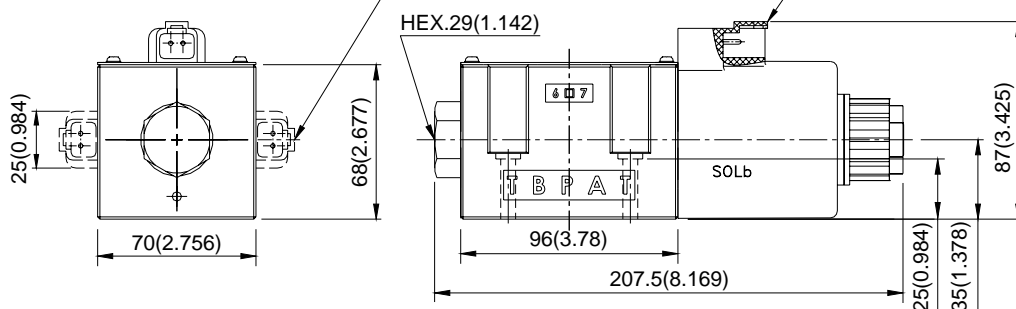



SOLENOID OPERATED DIRECTIONAL VALVE DEUTSCH CONNECTION TYPE

Mounting Surface: ISO 4401-AC-05-4-A

● SWH-G03-C* BS/B* S-D*-51-*-*

UNIT: mm(inch)

WEIGHT: 4kgs(9.68lbs)

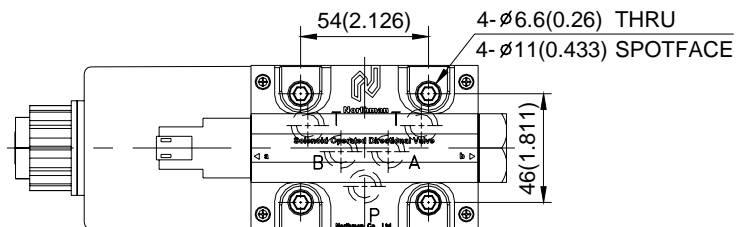

CONNECTOR DETAILS
EQUIVALENT TO DEUTSCH COMPANY
RECEPTACLE: DT04-2P
RECEPTACLE WEDGE: W2P
PIN CONTACT:0460-202-16141

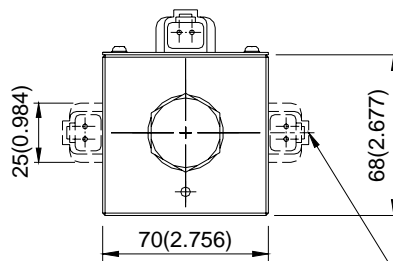
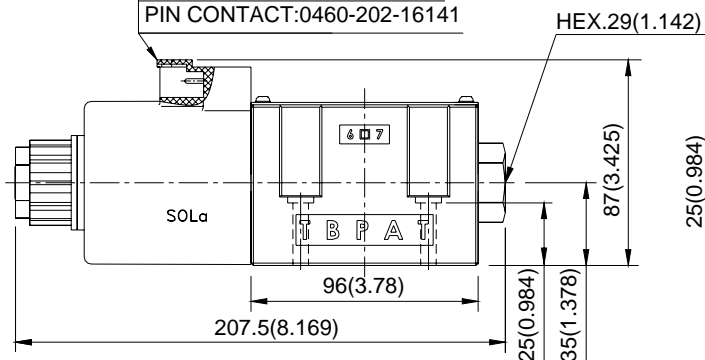

THREE POSITIONS OF CABLE
CONNECTIONS ARE AVAILABLE
BY LOOSENING "LOCK NUT"
AS SHOWN

* DETAILS OF PLUG
EQUIVALENT TO DEUTSCH COMPANY
PLUG: DT06-2S
PLUG WEDGE: W2S
SOCKET CONTACT:0462-201-16141